

Title:	DS-K4H250/450/258 series magnetic lock connect to DS-K2800 series Access Controller	Version:	v1.0	Date:	01/11/2018
Product:	Access Control Device	Page:	1 of 9		



DS-K4H250/450/258 series magnetic lock connect to DS-K2800 series Access Controller

Preparation

Connecting magnetic lock to access controller is mainly applied to swiping card to open the door for exiting. For magnetic lock and access controller in this document, please check the table below:

Magnetic Lock	Access Controller
DS-K4H250S	DS-K2801 DS-K2802 DS-K2804
DS-K4H250D	
DS-K4H450D	
DS-K4H258S	DS-K2804
DS-K4H258D	

Note

This document is simply used to guide users how to wire correctly and ensure access controllers can control locks.

The access controller model in this document is DS-K2804.

Part 1 is mainly for magnetic lock wiring, and Part 2 and Part 3 are mainly for the situation that users could get the door status on iVMS-4200 Client.

Notice

1. Please cut off power supply before wiring;
2. Please use a tool to screw magnetic lock screws in following picture, and remove the cover of magnetic lock, find V+/V- and NO/NC & COM interfaces of magnetic lock in following picture;

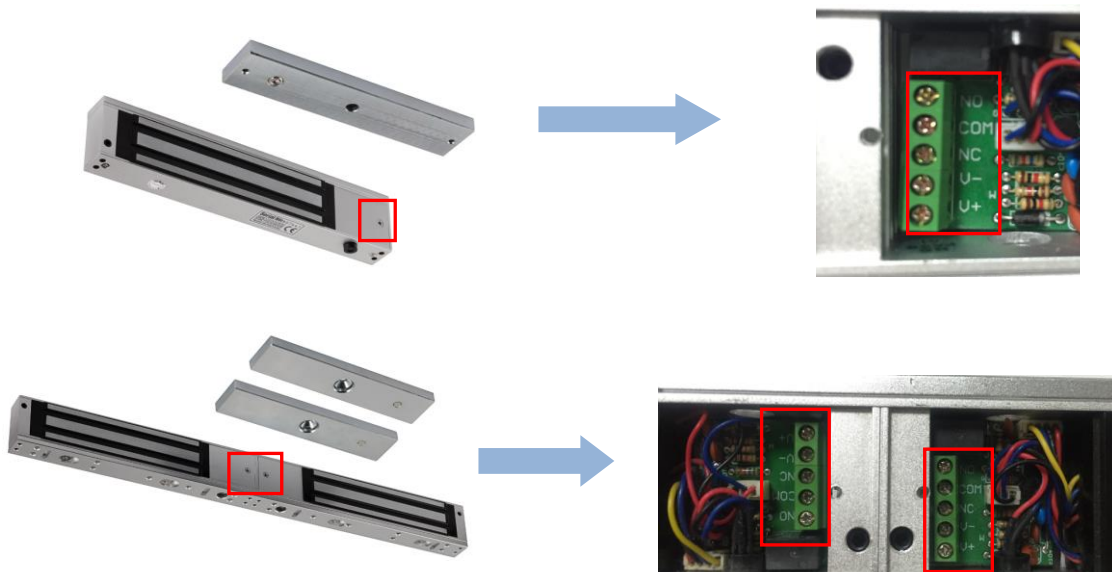



Title:	DS-K4H250/450/258 series magnetic lock connect to DS-K2800 series Access Controller	Version:	v1.0	Date:	01/11/2018
Product:	Access Control Device	Page:	2 of 9		



Interface	Description	Note
V+/V-	Power Supply	
NO/NC, COM	Door Magnetic Singnal Output	DS-K4H258S/D series magnetic locks don't have NO/NC and COM interfaces

3. Correspondingly, there are lock and door magnetic interfaces in DS-K2800 series access controllers, as pictures show:

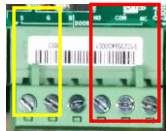
Note: means lock interface; means door magnetic interface;

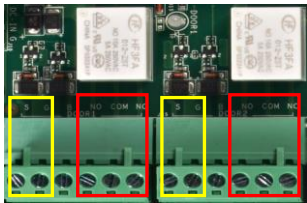
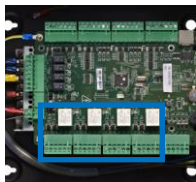
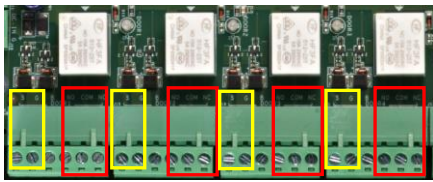
Access Controller	Interface
DS-K2801 	
DS-K2802 	
DS-K2804 	

Part 1: Lock+ & Lock- Wiring

DS-K4H250S & DS-K4H258S

Please connect as the following picture:

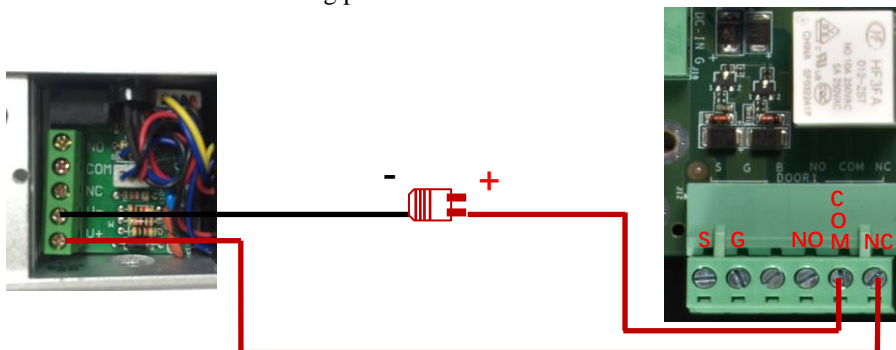

Title:	DS-K4H250/450/258 series magnetic lock connect to DS-K2800 series Access Controller	Version:	v1.0	Date:	01/11/2018
Product:	Access Control Device	Page:	3 of 9		



Magnetic lock LED status:

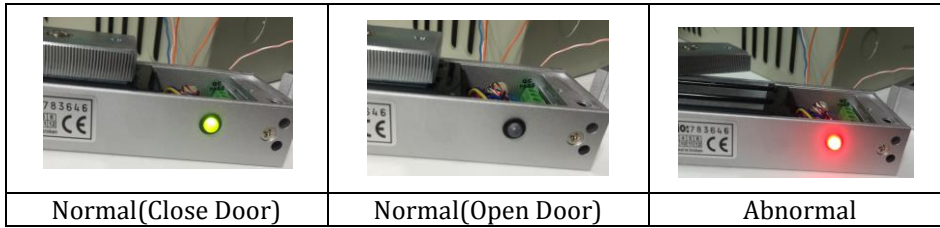

DS-K4H250D & DS-K4H450D & DS-K4H258D

Please connect as the following picture:

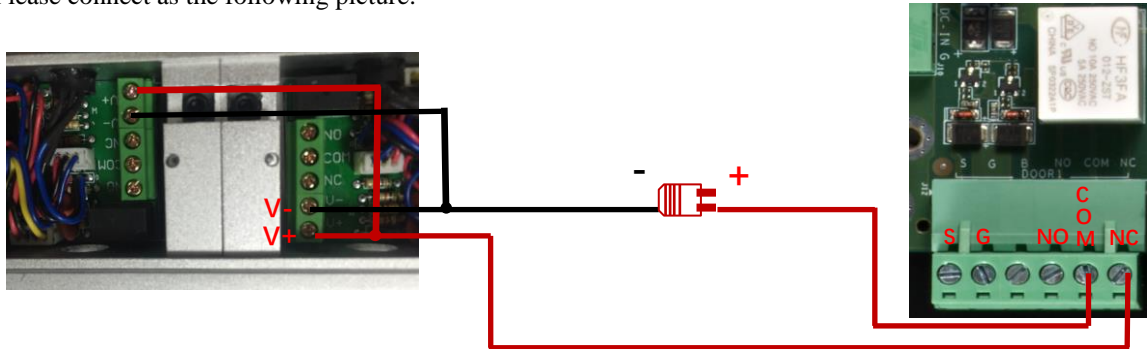

Magnetic lock LED status:

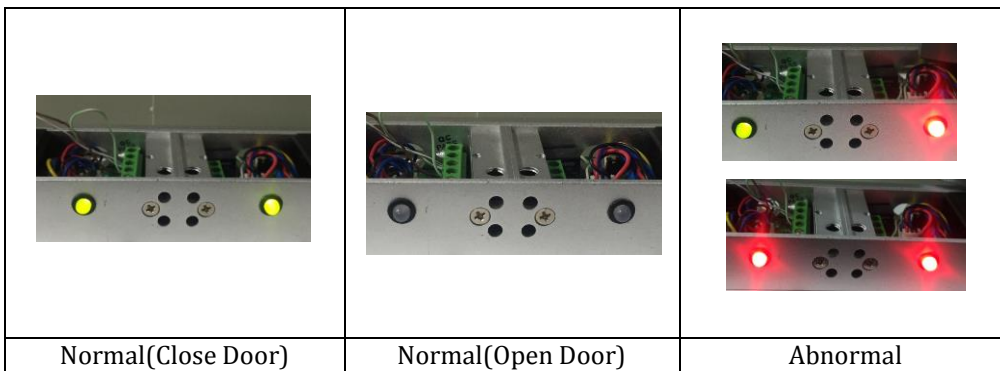

Part 2: Lock+ / Lock- & NC / COM Wiring

Step 1:

DS-K4H250S

Please connect as the following picture:

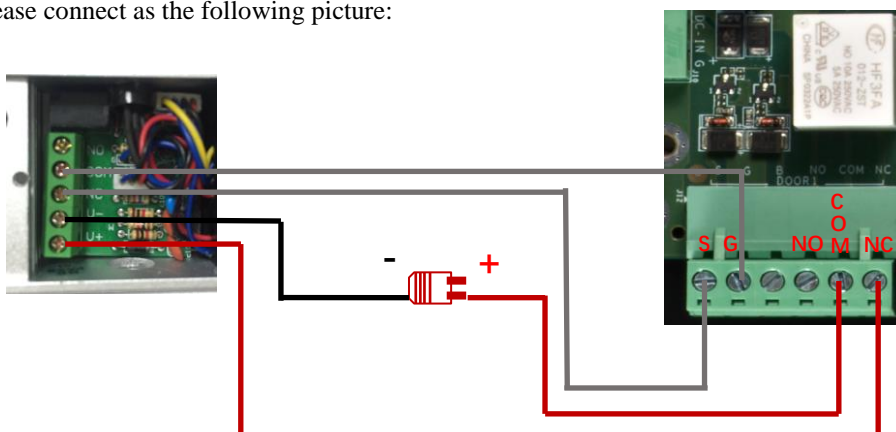

Title:	DS-K4H250/450/258 series magnetic lock connect to DS-K2800 series Access Controller	Version:	v1.0	Date:	01/11/2018
Product:	Access Control Device	Page:	4 of 9		



Magnetic lock LED status:

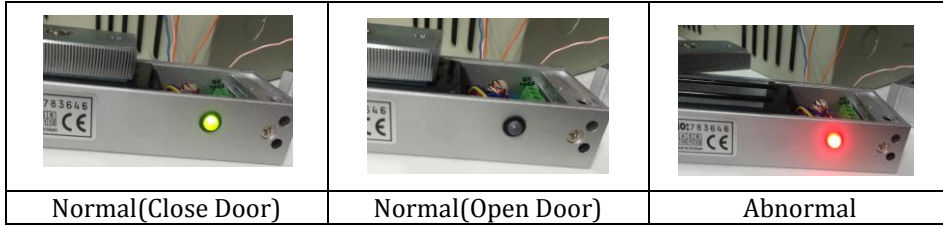

DS-K4H250D & DS-K4H450D

Please connect as the following picture:

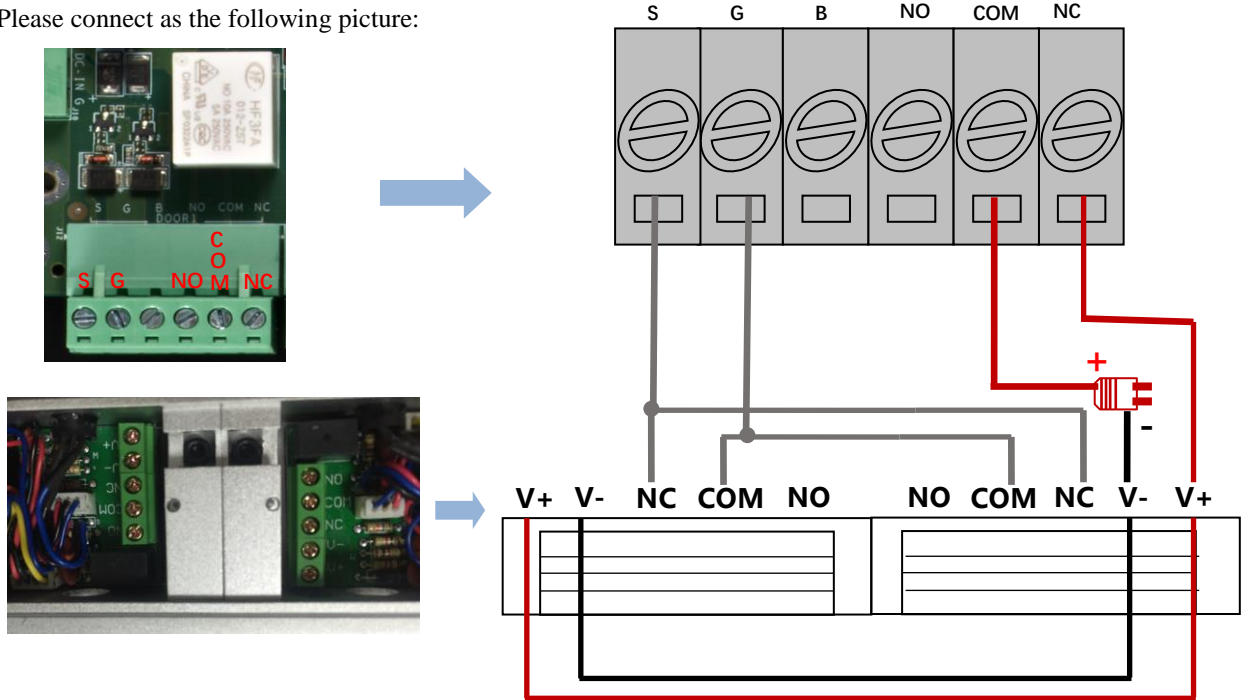

Magnetic lock LED status:

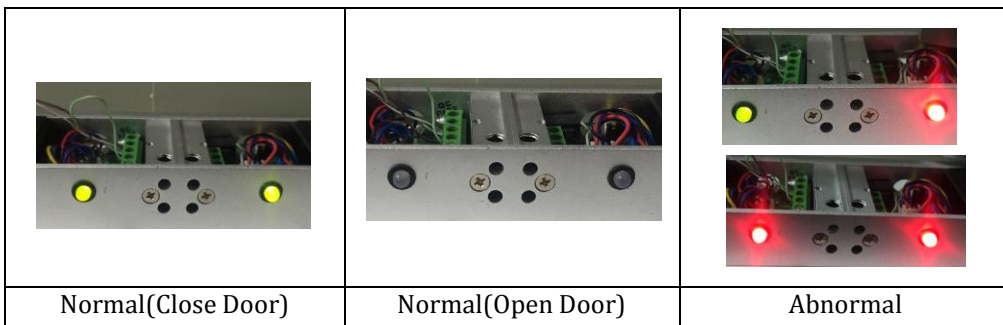

Step 2:

Add access controller to iVMS-4200 Client;

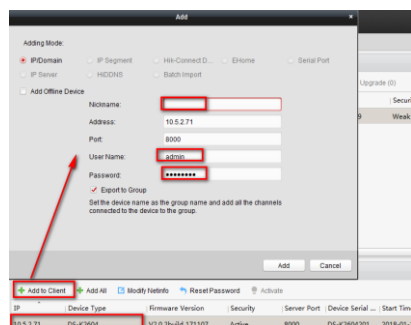

Title:	DS-K4H250/450/258 series magnetic lock connect to DS-K2800 series Access Controller	Version:	v1.0	Date:	01/11/2018
Product:	Access Control Device	Page:	5 of 9		



Step 3:

Click **Tool** → **Device Arming Control**, check your access controller arming status;

The icon  means device was armed by iVMS-4200 Client;

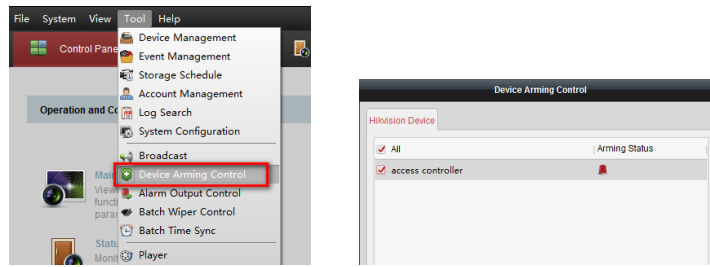



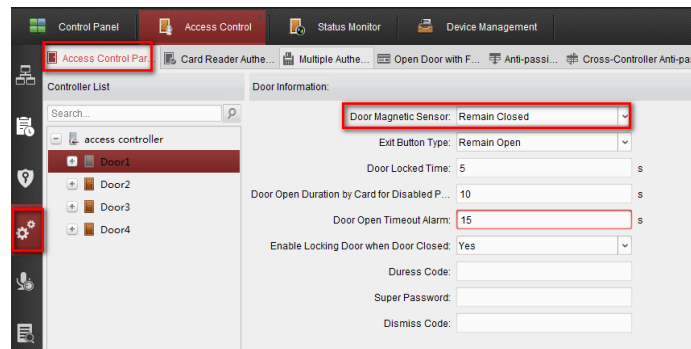

Step 4:

Enter **Access Control** → **Advanced Function** → **Access Control Parameters** interface, set **Door Magnetic Sensor** as **Remian Closed**, and it should be consistent with the wiring of Door Magnetic Singnal Output;



Step 5:

Enter **Status Monitor** → **Door Status** interface, open the door, check door status on iVMS-4200 Client and the magnetic lock LED status;

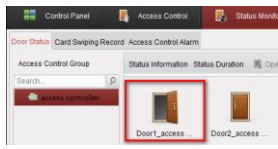
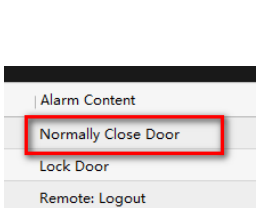
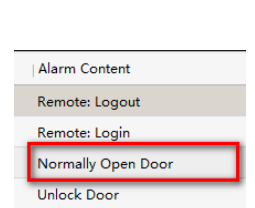
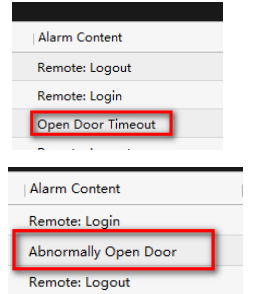
Magnetic Lock LED status			
Door Status			
Alarm Event			

Title:	DS-K4H250/450/258 series magnetic lock connect to DS-K2800 series Access Controller	Version:	v1.0	Date:	01/11/2018
Product:	Access Control Device	Page:	6 of 9		



Part 3: Lock+/Lock- & NO/COM Wiring

Step 1:

DS-K4H250S

Please connect as the following picture:

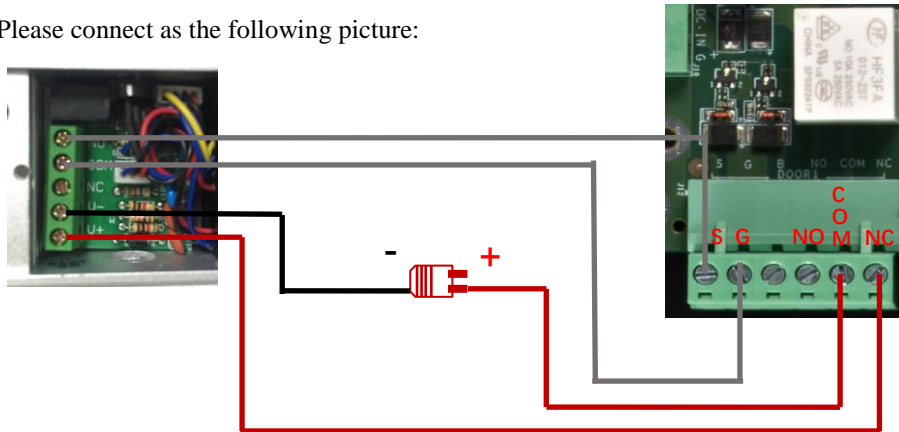

Magnetic lock LED status:

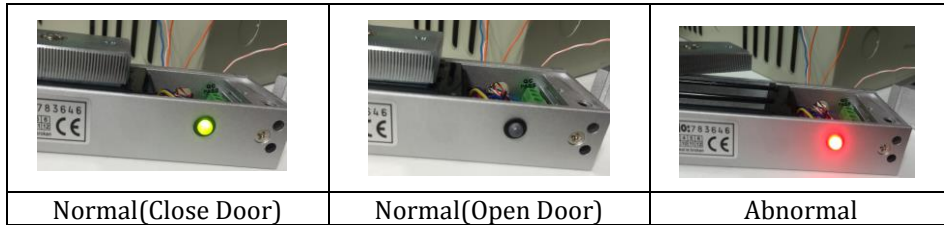

DS-K4H250D & DS-K4H450D

Please connect as the following picture:

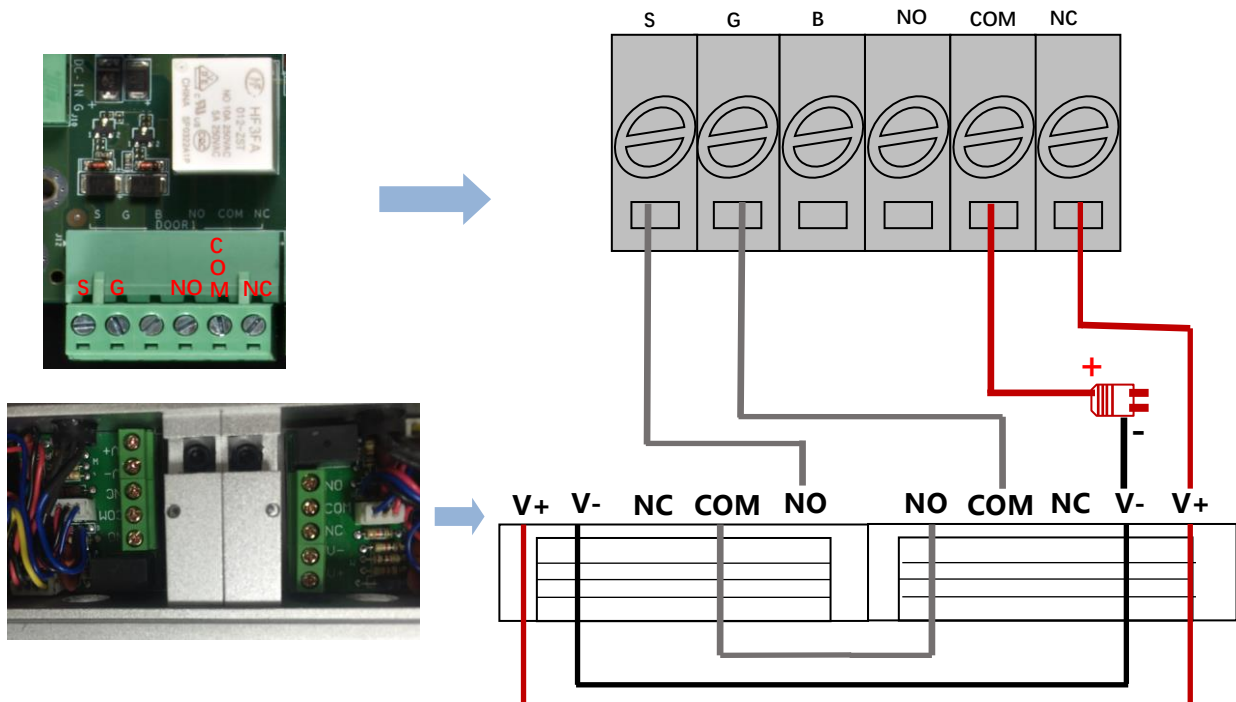

Title:	DS-K4H250/450/258 series magnetic lock connect to DS-K2800 series Access Controller	Version:	v1.0	Date:	01/11/2018
Product:	Access Control Device	Page:	7 of 9		



Magnetic lock LED status:

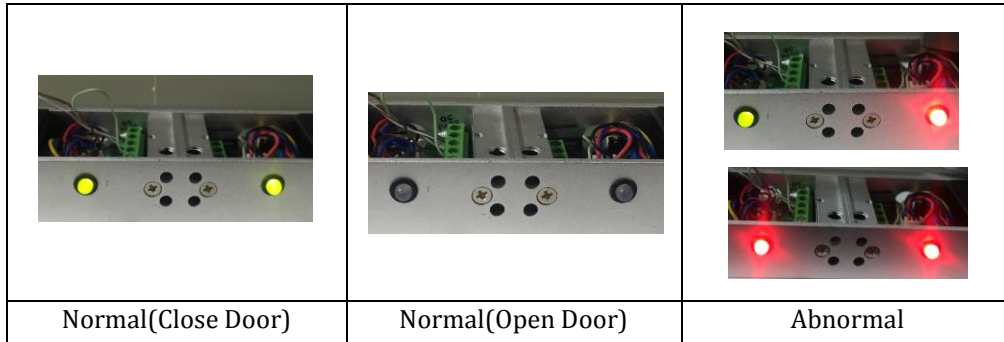

Step 2:

Add access controller to iVMS-4200 Client;

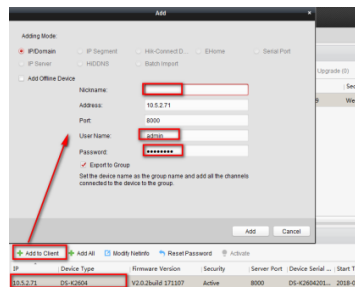

Step 3:

Click **Tool** → **Device Arming Control**, check your access controller arming status;

The icon  means device was armed by iVMS-4200 Client;

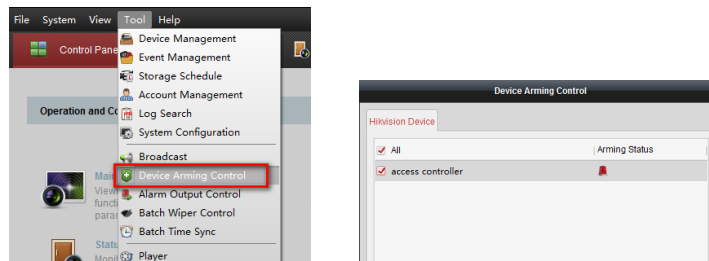

Step 4:

Enter **Access Control** → **Advanced Function** → **Access Control Parameters** interface, set **Door Magnetic Sensor** as **Remian Open**, and it should be consistent with the wiring of Door Magnetic Singnal Output;

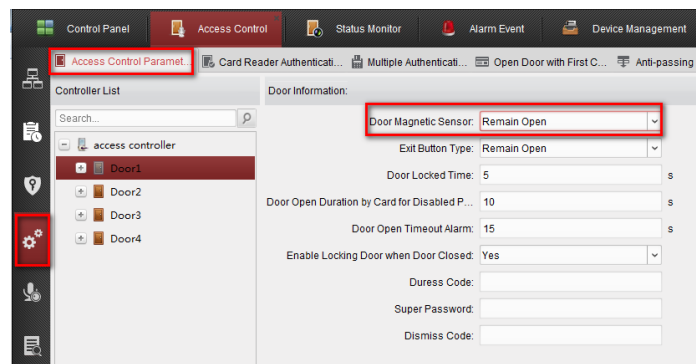

Title:	DS-K4H250/450/258 series magnetic lock connect to DS-K2800 series Access Controller	Version:	v1.0	Date:	01/11/2018
Product:	Access Control Device	Page:	8 of 9		



Step 5:

Enter **Status Monitor** → **Door Status** interface, open the door, check door status on iVMS-4200 Client and the magnetic lock LED status;

Magnetic Lock LED status			
Door Status			
Alarm Event			

NOTE: Abnormal in *Magnetic lock LED status* part could be displayed in following scenario, open door timeout, abnormally open door(by force), as well as not standard installation causing armature plate and lock body contact are not fully fitted.

Title:	DS-K4H250/450/258 series magnetic lock connect to DS-K2800 series Access Controller	Version:	v1.0	Date:	01/11/2018
Product:	Access Control Device	Page:	9 of 9		



First Choice for Security Professionals
***HIK*VISION Technical Support**